

25.6V 2.5KWH

LiFePO4 Rack-Mounted Home Energy Storage Battery Solution



CONNECT WITH OFFGRID/HYBRID INVERTER



BACKUP BATTERY



LITHIUM-ION BATTERY



3 YEAR PRODUCT WARRANTY

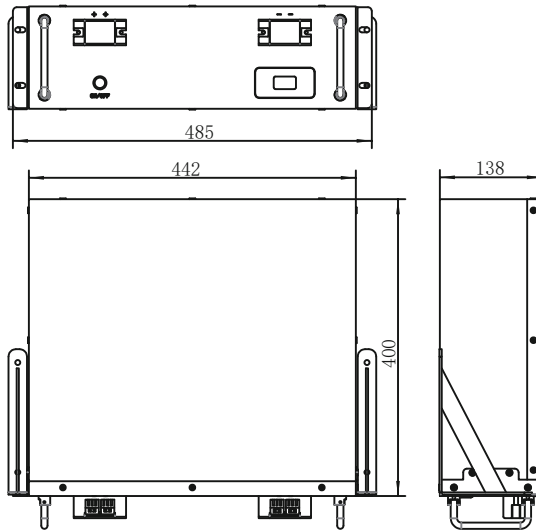

Dimension Drawing

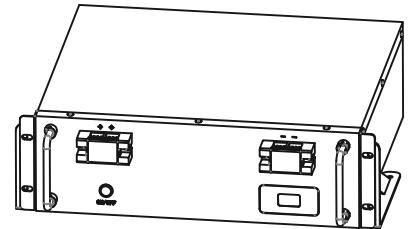

Compatible Inverter



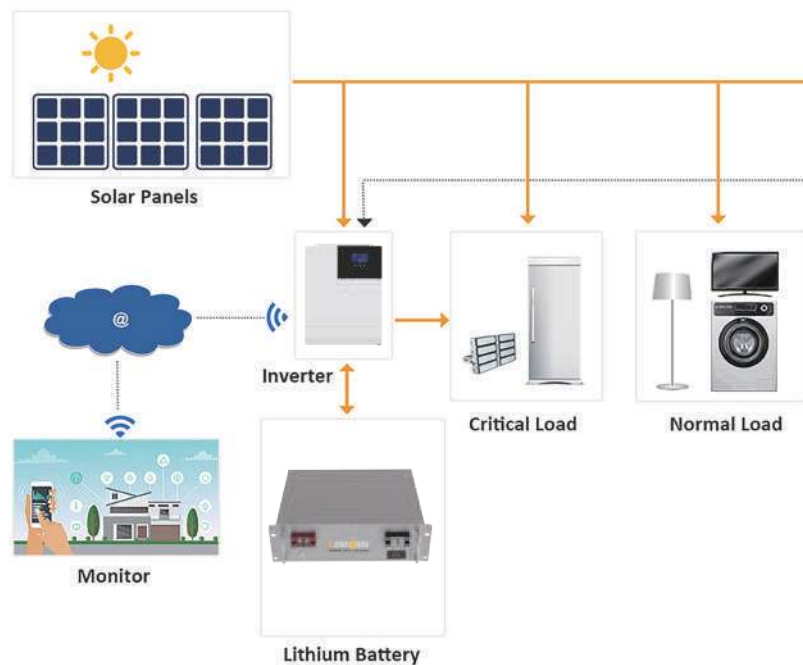

Parameters

ECO 2.5

Nominal Energy	2.5kwh
Nominal Voltage	25.6V
Nominal Capacity	100Ah
Cell Type	LFP
Standard Charge Voltage	29.2V
Max Charge Current	120A
Discharge Cut-Off Voltage	20V
Max Discharge Current	120A
Parallel Function	Support Connection In Series & Parallel
Load Power	≤3000W
Calendar Life	6+ Years @25°C
Cycle Life *	≥3000 Cycles
Charge temperature range	0~65°C
Discharge temperature range	-20~65°C
Certification	Cell:UL1642 / IEC62619 / CE / ROHS / MSDS / UN38.3 Pack:MSDS / UN38.3
Dimensions	442*440*138mm(Without ear)
Weight	24.5Kg±0.3
Installation method	Wall mounted/Rack Mounted

*Test Condition: 80% DOD, 0.2C charge & discharge @25°C

● **Different current/Temperature Discharge curves**

Different Rate Discharge Curve @25°C

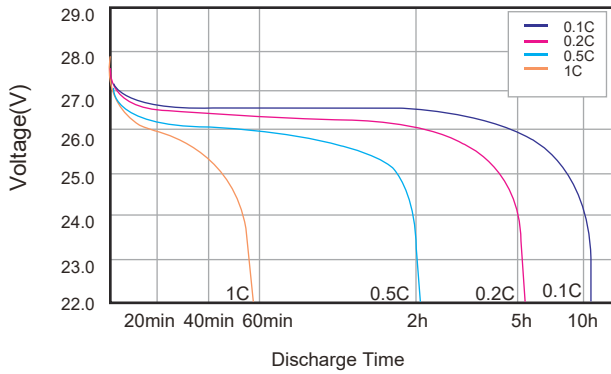

Different Temperature Discharge Curve @0.5C

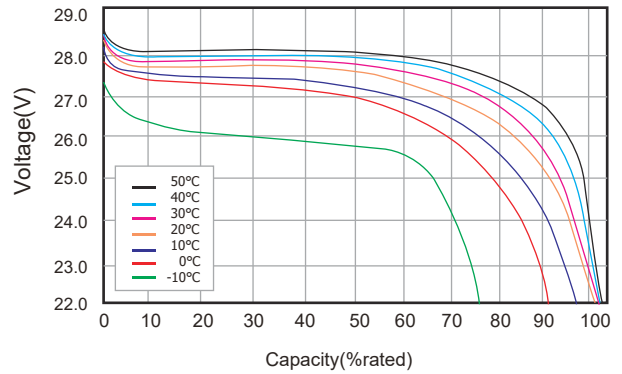

● **Charging and Discharge curve**

Charge and Discharge at 25°C,0.5C

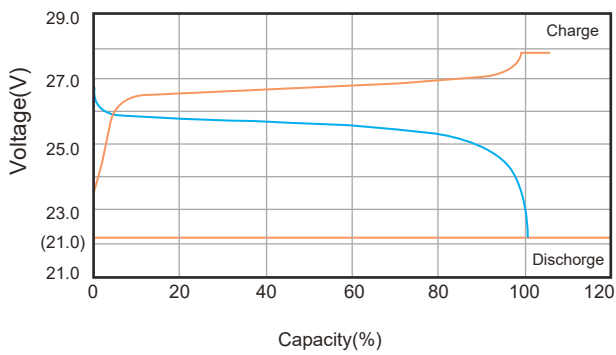

Different Temperature Self Discharge Curve

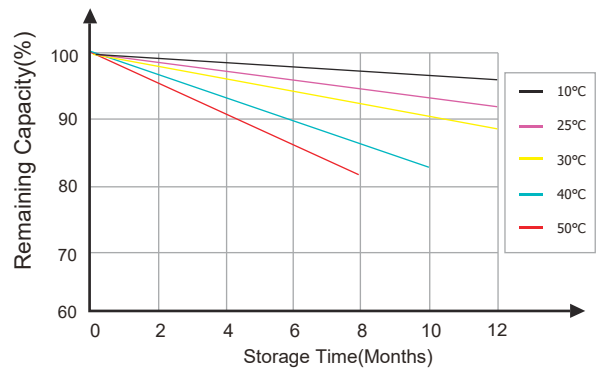

● **Cycle Life Curve**

Different Discharge Depth Life Curves & 25°C,0.5C

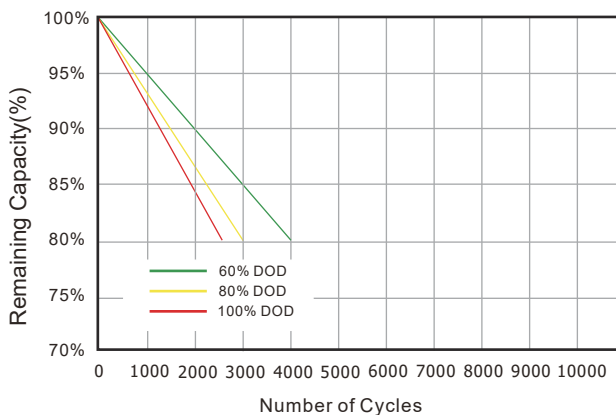

Different Discharge Depth Life Curves & 40°C,0.5C

